

WELLNESS   
EXPERIENCE

#WELLNESS





#WELLNESS



# #INDICE

## INDEX

#COMPANY	06
#NU	11
#CLOUD	21
#SFERA	31
#HARMONIA	41
#MODULAR	51
#SHOWERHEAD	61
#SQUARE&ROUND	71
#FIMABOXES	79

DIMENSIONE TOTALE  
TOTAL SIZE

CODICE E GETTI  
CODE AND SPRAY

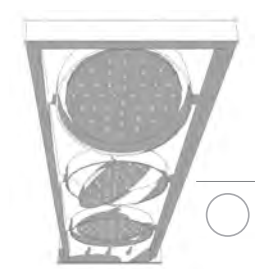
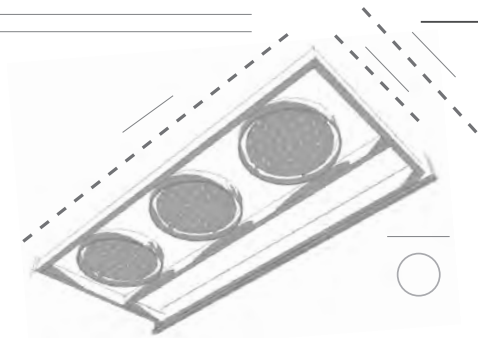

SPECIFICHE TECNICHE  
TECHNICAL SPECIFICATIONS



MATERIALI  
MATERIALS

DIMENSIONI GETTI  
JETS DIMENSIONS

INSTALLAZIONI  
INSTALLATIONS

PORTATA CONSIGLIATA A 3BAR  
SUGGESTED FLOW RATE 3BAR

FUNZIONI/GETTI  
FUNCTIONS/JETS

FINITURE  
FINISHING



# SCOPRI IL TUO WELLNESS

## DISCOVER YOUR WELLNESS

ESEMPIO DI COMPOSIZIONE DOCCIA  
EXAMPLE SHOWER COMPOSITION

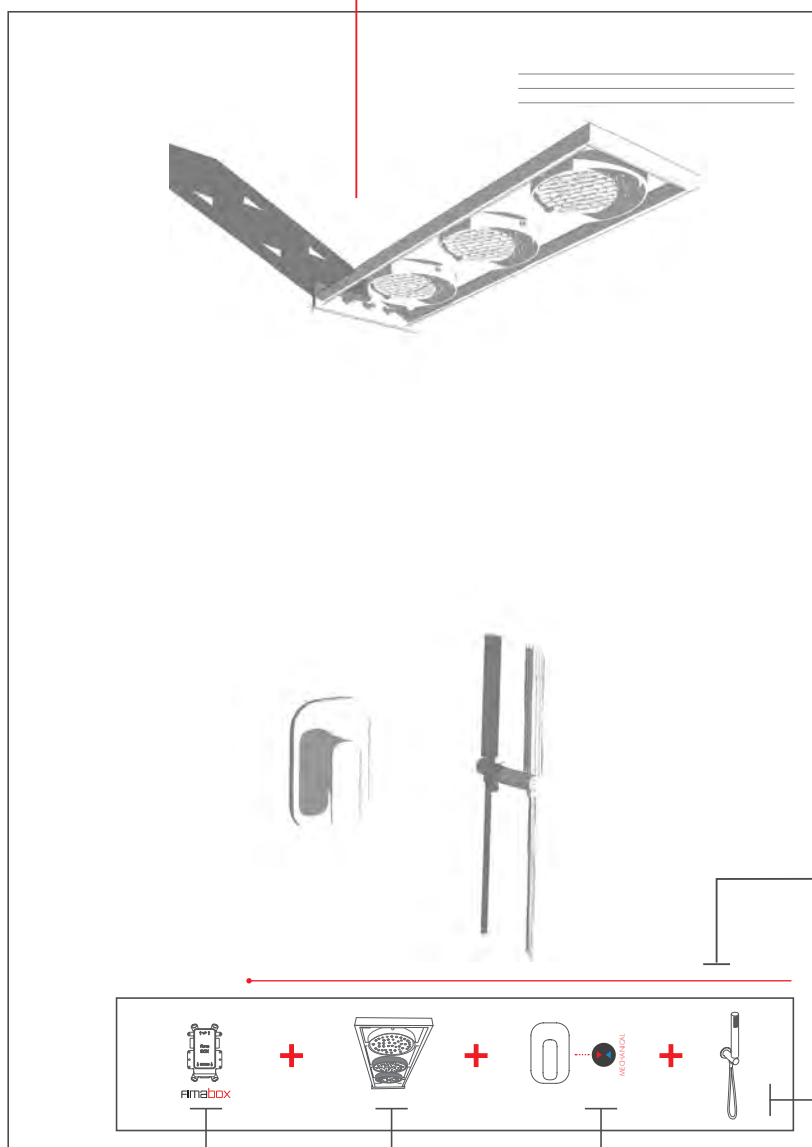

ELEMENTI DELLA COMPOSIZIONE  
ELEMENTS OF COMPOSITION

ALTRI ELEMENTI PER  
PERSONALIZZARE IL TUO  
SPAZIO DOCCIA  
OTHER ITEMS TO CUSTOMISE  
YOUR SHOWER

INSTALLA IL SOFFIONE  
CHE PREFERISCI  
INSTALL YOUR FAVOURITE  
SHOWERHEAD

SCOPRI TUTTI I CORPI INCASSO  
FIMABOXES A PAG. 79  
FIND OUT ALL FIMABOXES BUILT-IN  
BOXES LOOKING AT PAG. 79

SCEGLI LA PARTE ESTERNA  
ADATTA AL TUO STILE  
CHOOSE THE EXTERNAL PART  
MOST SUITED TO YOUR STYLE

# #COMPANY

Tecnologia, estetica ed elevate prestazioni: FIMA Carlo Frattini propone da oltre 50 anni rubinetteria di altissima qualità destinata a durare nel tempo e capace di dare valore aggiunto ad ogni progetto. L'Azienda ha assunto negli anni un taglio innovativo ed in continua evoluzione, grazie alla creatività, al design e alle nuove tecnologie, che differenziano le sue collezioni. FIMA, infatti, si rinnova costantemente, come dimostrano l'alto livello progettuale e qualitativo della produzione, i continui investimenti in ricerca, la forte espansione nazionale e internazionale, la professionalità del team aziendale. Questo atteggiamento ha portato l'Azienda ad interpretare e anticipare le esigenze contemporanee e future del mercato, proponendo prodotti all'avanguardia per design e tecnologia, curati singolarmente in ogni dettaglio.

Technology, aesthetics and performance: FIMA Carlo Frattini has been offering for more than 50 years high quality faucets designed to last over time and able to give added value to each project. Over these years the Company has taken an innovative and evolving feature, thanks to its creativity, design and new technologies, which differentiate its collections from others. FIMA, in fact, is being continually upgraded by way of its high level of designs, quality of production, continuous investment in research, the strong national and international expansion and the professionalism of the corporate team. This attitude has led the company to understand and anticipate the contemporary and future market needs by offering technically and esthetically advanced products, which are treated individually in every detail.

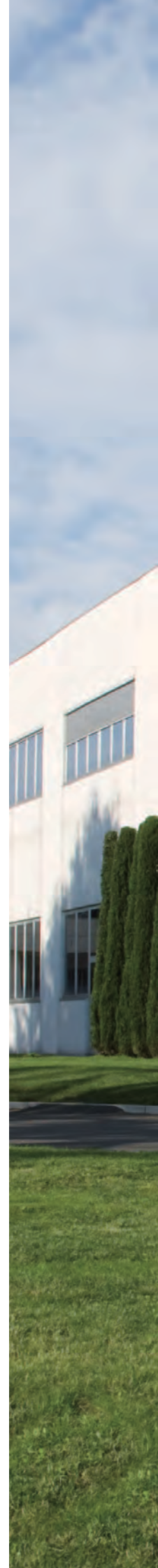



fima | CARLO FRATTINI<sup>®</sup>  
FABBRICAZIONE



# #GREEN

FIMA CARLO FRATTINI da anni evolve i propri processi produttivi finalizzandoli ad una costante riduzione di risorse, materiali ed energia ed operando un controllo costante sulle materie prime, sui consumi e sull'impatto ambientale di tutte le fasi di produzione e commercializzazione dei propri prodotti.

Un'azienda eco sostenibile, alimentata da energia auto-prodotta e in grado di realizzare prodotti sicuri per la salute e per l'ambiente con un basso impatto ambientale.

FIMA CARLO FRATTINI for many years has been constantly developing its production processes in order to reduce the use of resources, materials and energy. Furthermore all FIMA Carlo Frattini projects are developed considering all the steps of a product's life, from its manufacturing to the shipment till its dismantlement.

An environmentally friendly company, powered by self-produced electricity and able to produce products safe for human health and the environment with a very low environmental impact.

# #QUALITY

I migliori materiali e tecnologie all'avanguardia per garantire un utilizzo quotidiano impassibile al trascorrere del tempo. Fima Carlo Frattini sposa un approccio globale alla qualità che deriva da un'attenzione all'innovazione tecnologica, adottando processi industriali all'avanguardia, scegliendo le migliori materie prime. Tutti i prodotti vengono sottoposti a minuziosi e severi controlli in ogni fase di lavorazione e sono progettati in modo da rispettare tutte le più rigide normative internazionali. Ulteriore testimonianza di questa filosofia improntata alla qualità totale è la garanzia che si estende per ben 7 anni su tutta la produzione.

Best materials and cutting-edge technologies as a guarantee for an everyday use unchanging over time. FIMA Carlo Frattini follows a global approach to quality coming from a particular attention to technology innovation, by adopting cutting-edge industrial processes, choosing the best raw materials. Detailed strict controls are carried out on all the products in every production phase and all the items are designed in order to respect the most stringent international regulations. Its seven-year extended warranty on all the product is a further evidence of this philosophy based on total quality.

# #DESIGN

Prodotti unici nel loro genere, studiati per massimizzare il comfort di utilizzo e con un inconfondibile tocco Made in Italy. Convinta del potere della creatività, del design e delle nuove tecnologie, l'Azienda ha assunto negli anni un taglio innovativo e in continua evoluzione. Questo atteggiamento l'ha portata a interpretare e anticipare le esigenze presenti e future del mercato, proponendo prodotti all'avanguardia per design e tecnologia. Studiati per massimizzare il comfort di utilizzo e caratterizzati da uno stile unico sono progettati da nomi noti del design.

One-of-a-kind products, designed to maximize the comfort in use with an unmistakable hint of Made in Italy. The Company, firmly confident of the power of creativity, design, and new technologies, has developed over the years innovative and ever-changing traits. This approach has led it to interpret and anticipate the current and future market needs, by proposing state-of-the-art products in terms of design and technology. Designed to maximize the comfort in use and characterised by a unique style, all the items are designed by well-known designers.

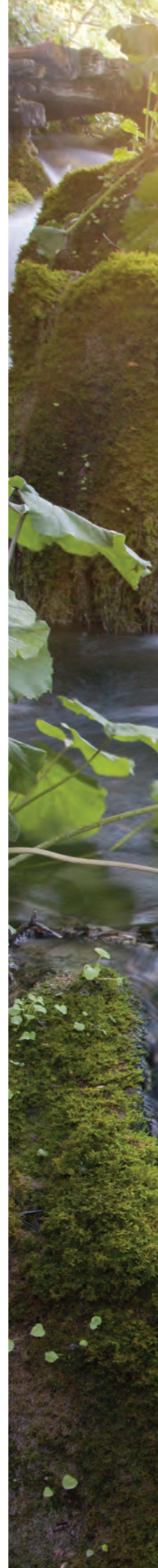





#NU

AWARDWINNER2017  
DESIGN **PLUS**

DAVIDE VERCELLI design

NU

#DESIGN













L'ORIENTAMENTO FLUIDO  
DEI SOFFIONI ACCAREZZA  
IL TUO CORPO

THE FLUID ORIENTATION OF THE  
SHOWERHEADS CARESSES YOUR BODY

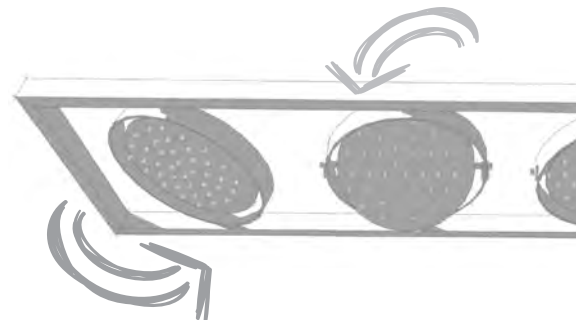
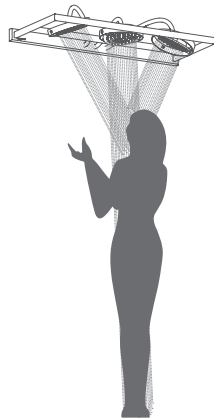

# 3 DIVERSE INSTALLAZIONI

DIFFERENT INSTALLATIONS

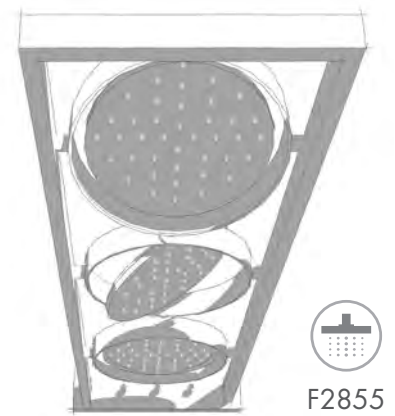
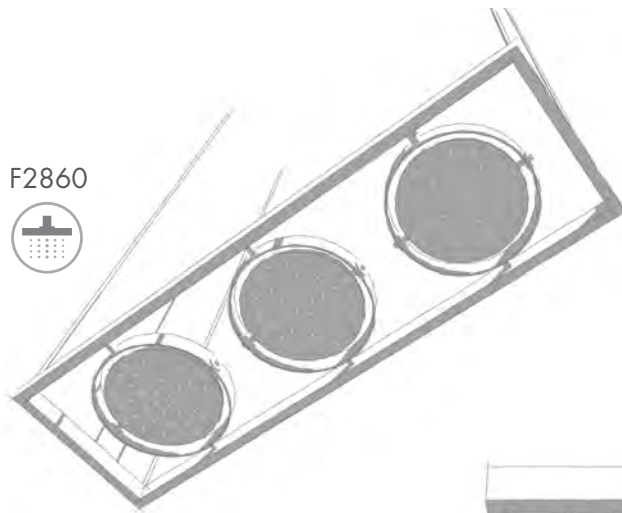
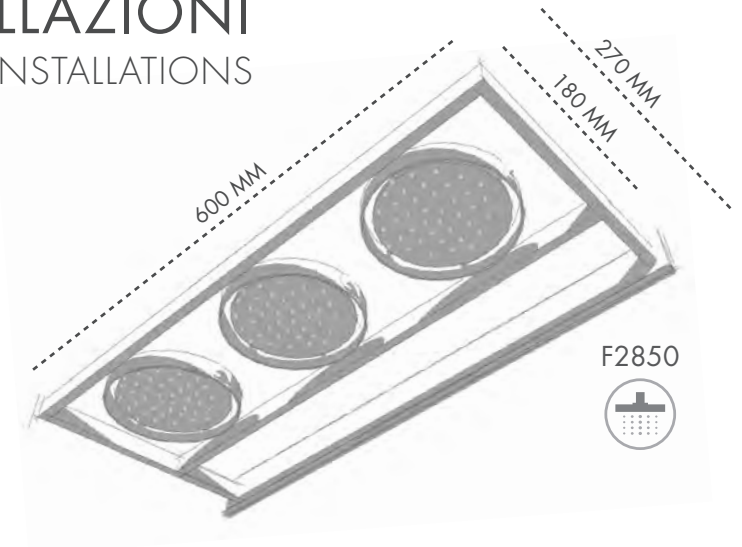

## SPECIFICHE TECNICHE • TECHNICAL SPECIFICATIONS



ACCIAIO INOX  
STAINLESS STEEL



20 L/MIN.



Ø 120 MM



GETTO A PIOGGIA  
RAIN FLOW



PARETE • SOFFITTO • SOSPESO  
WALL • CEILING • SUSPENDED



CROMO  
CHROME



# COMPOSIZIONE 1

COMPOSITIONS

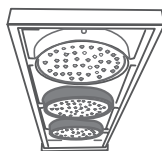
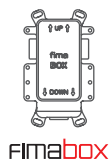
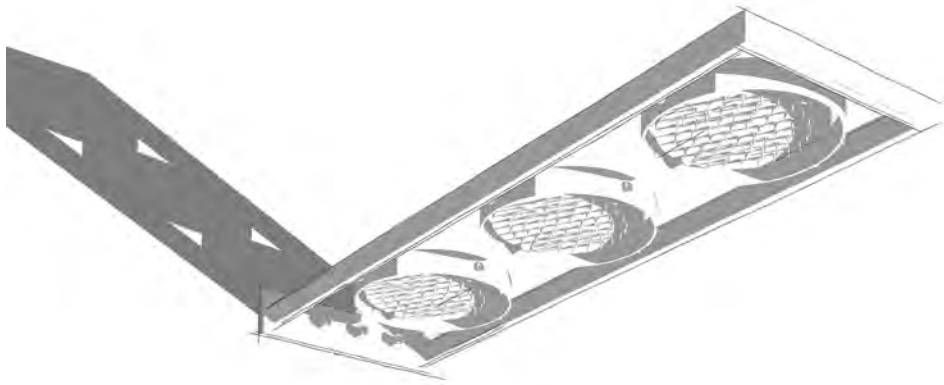



#CLOUD



AWARDWINNER2015  
**DESIGN PLUS**

CLOUD

#GREEN











## ACQUA E LUCE FONTI DI ENERGIA E BENESSERE

WATER AND LIGHT: SOURCE OF  
ENERGY AND WELLNESS



**F2652**  
(300 mm braccio a soffitto - ceiling bracket)

**F2653**  
(150 mm braccio a soffitto - ceiling bracket)



**F2652C•B•N**  
(300 mm braccio a soffitto - ceiling bracket)

**F2653C•B•N**  
(150 mm braccio a soffitto - ceiling bracket)

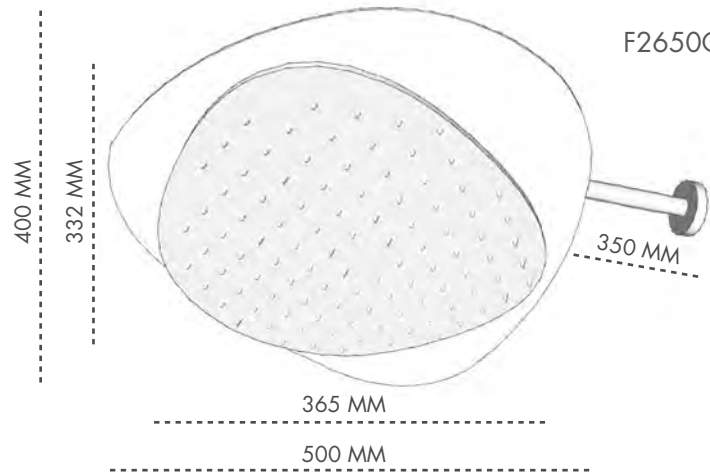

F2650



F2650C•B•N

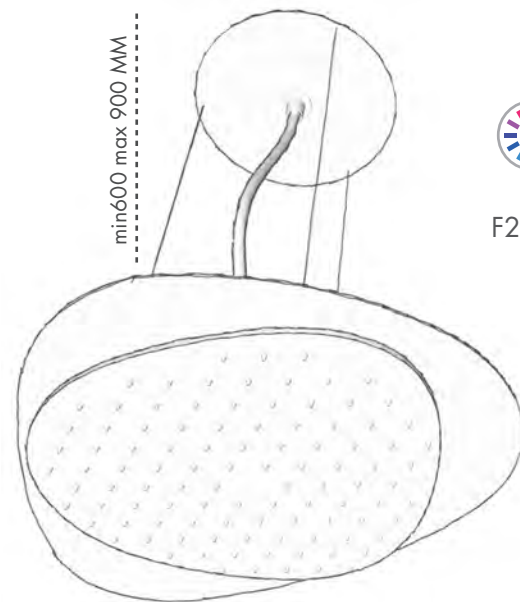

F2651



F2651C•B•N



### SPECIFICHE TECNICHE • TECHNICAL SPECIFICATIONS



ACCIAIO INOX  
STAINLESS STEEL



15 L/MIN.



365x330 MM



GETTO A PIOGGIA  
RAIN FLOW



PARETE•SOFFITTO•SOSPESO  
WALL•CEILING•SUSPENDED



CROMO•BIANCO•NERO  
CHROME•WHITE•BLACK  
(PIASTRA SUP - UPPER PLAT)





**CR** • CROMO CHROME



**BS** • BIANCO WHITE



**NS** • NERO BLACK

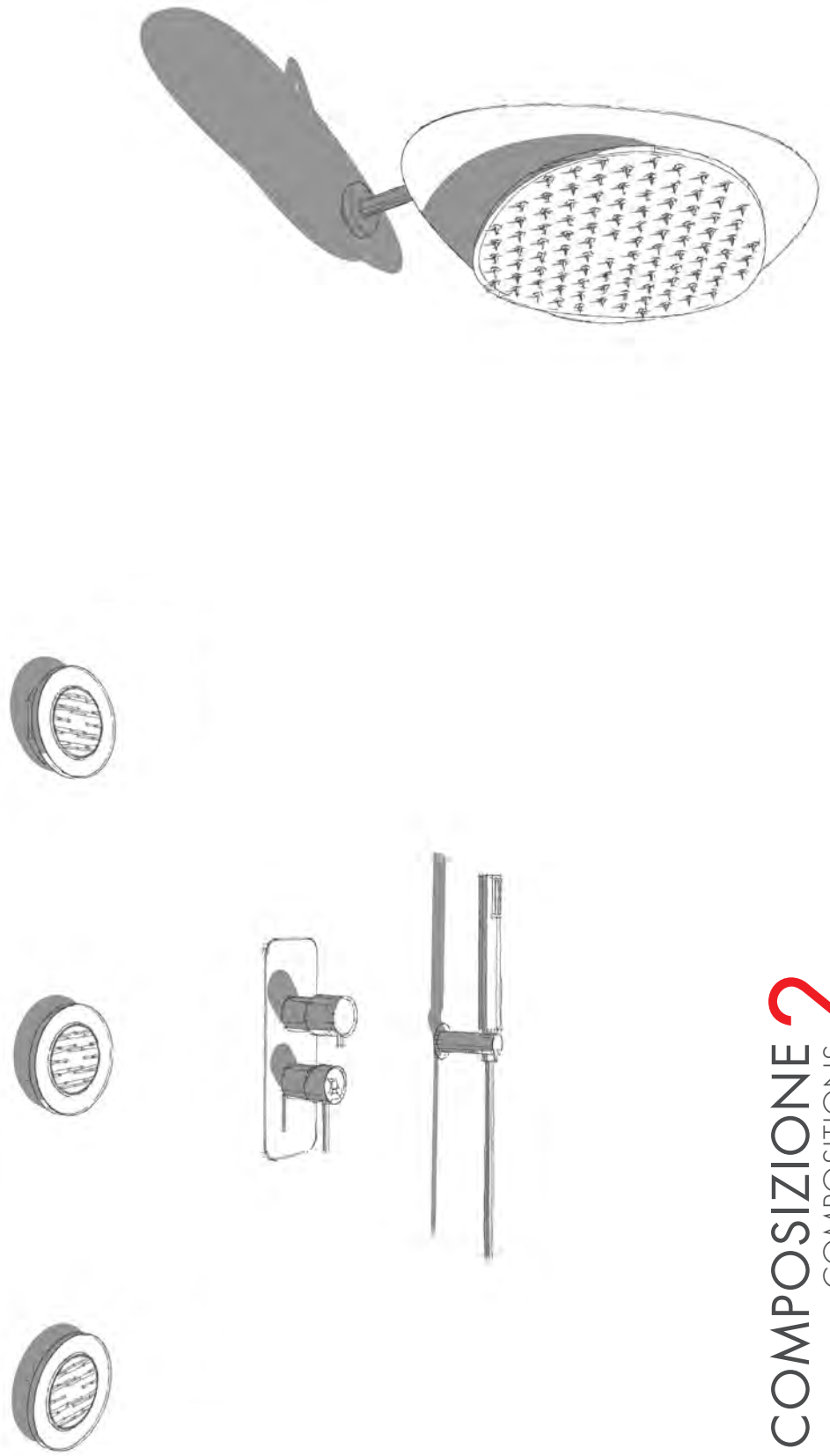

COMPOSIZIONE 2  
COMPOSITIONS

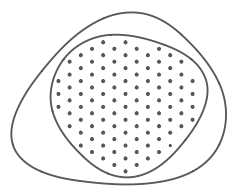
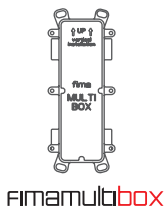

fimamultibox





#SFERA

AWARDWINNER2010  
**DESIGN PLUS**

MENEGHELLO PAOLELLI ASSOCIATI design

SFERA

#EMOTIONS











# 3 FINITURE FINISHINGS



**CR** • CROMO CHROME



**BS** • BIANCO WHITE



**NS** • NERO BLACK

## 2 POSSIBILITÀ DI INSTALLAZIONE CHOICES FOR THE INSTALLATION

F2340/1  
soffitto - ceiling

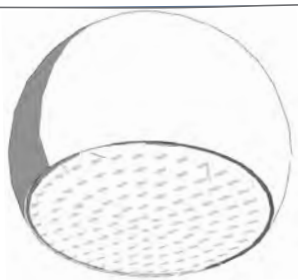

Ø 200 MM



F2340  
parete - wall

### SPECIFICHE TECNICHE • TECHNICAL SPECIFICATIONS



OTTONE  
BRASS



15 L/MIN.



Ø 200 MM



GETTO A PIOGGIA  
RAIN FLOW



PARETE • SOFFITTO  
WALL • CEILING



CROMO • BIANCO • NERO  
CHROME • WHITE • BLACK





# COMPOSIZIONE 3

COMPOSITIONS

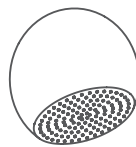
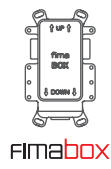
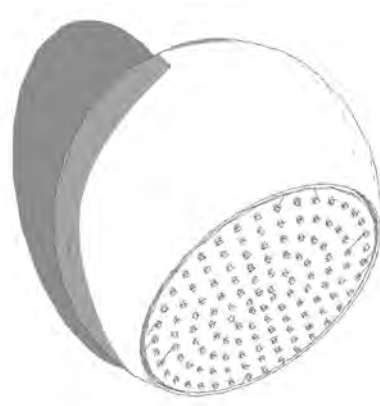
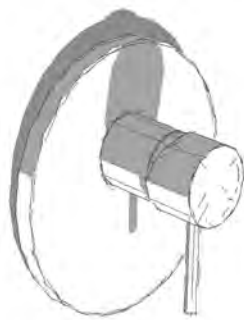



#HARMONIA





ARMONIA

#TECHNOLOGY







SPECIFICHE TECNICHE • TECHNICAL SPECIFICATIONS



ACCIAIO INOX  
STAINLESS STEEL



15 L./MIN.  
30 L./MIN.  
FOR 950x950



500x500 MM  
700x400 MM  
950x950 MM



PIOGGIA • CASCATA • NEBULIZZATO  
RAIN • WATERFALL • MIST SPRAY



SOFFITTO  
CEILING



CROMO  
CHROME



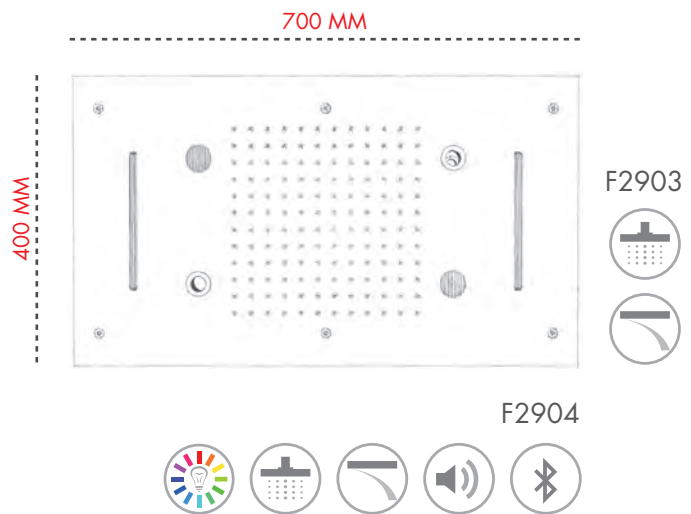
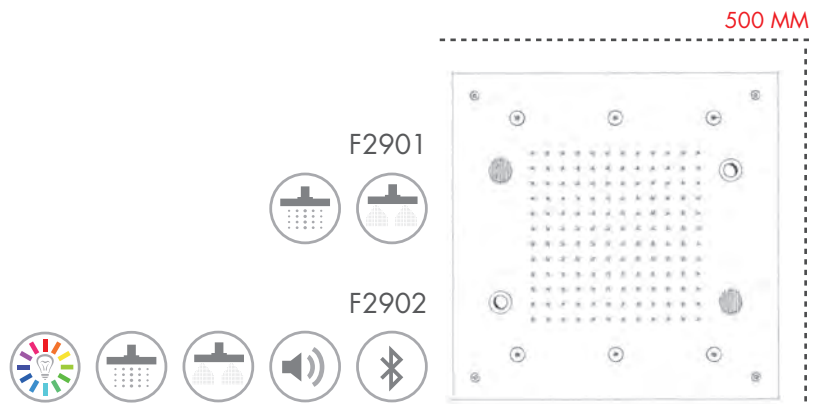
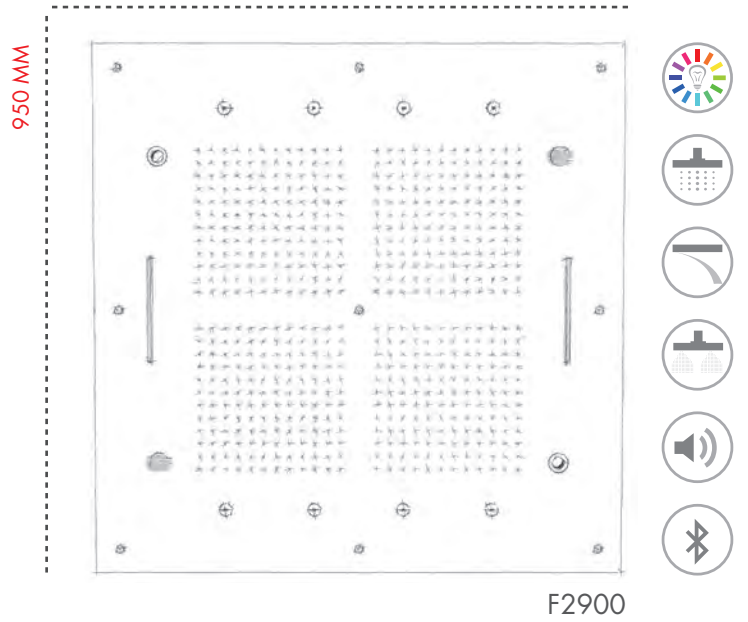

GIOCHI D'ACQUA,  
 LUCE E MUSICA  
 IN GRADO DI  
 GENERARE EMOZIONI

PLAY OF WATER, LIGHT AND MUSIC  
 SOURCE OF EMOTIONS



# COMPOSIZIONE 4

COMPOSITIONS

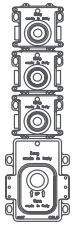
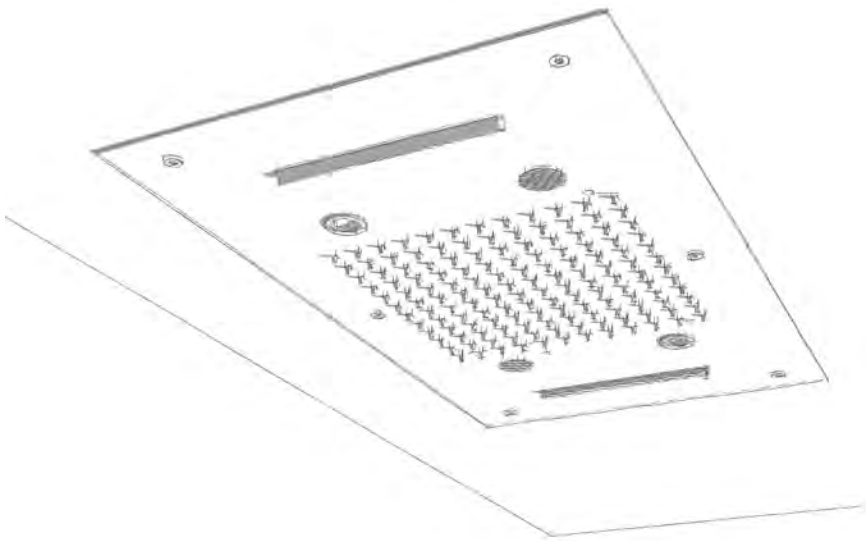

FIMathermbox

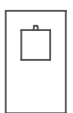
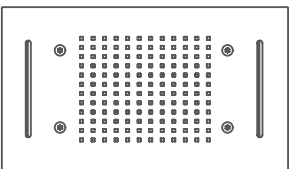

38

THERMOSTATIC

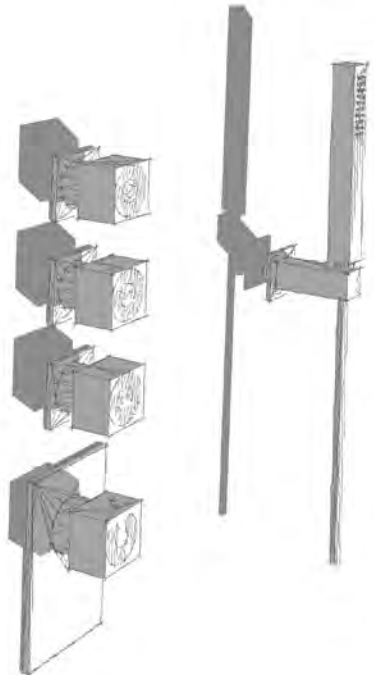
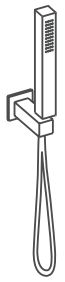



#MODULAR



ULAR

T











# 5 MODULI DIFFERENTI DIFFERENTS MODULES

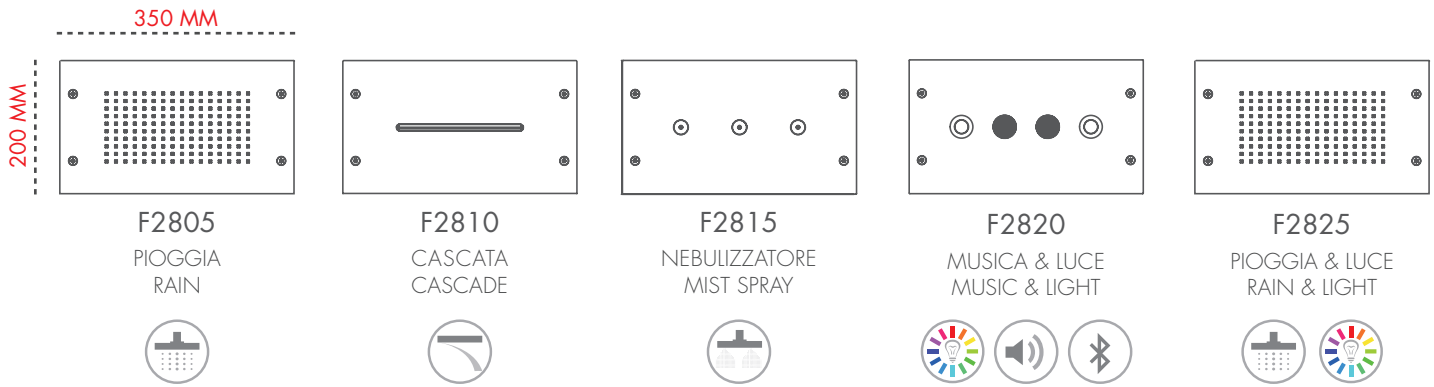

## COMPONI I TUOI SOFFIONI DOCCIA COMPOSE YOUR SHOWERHEADS

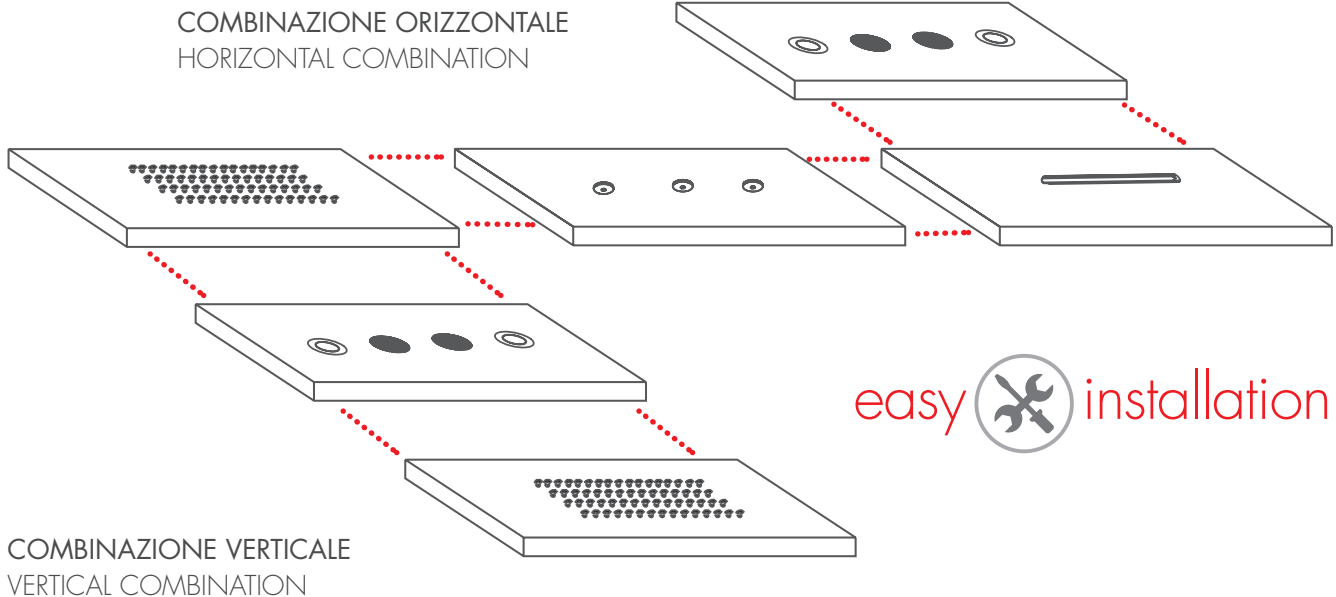

e • and...

PERSONALIZZA  
LA TUA INSTALLAZIONE  
CHOOSE YOUR PERSONAL INSTALLATION



## SPECIFICHE TECNICHE • TECHNICAL SPECIFICATIONS



ACCIAIO INOX  
STAINLESS STEEL



15 L·MIN.  
RAIN  
6 L·MIN.  
WATERFALL•MIST SPRAY



350x200 MM



PIOGGIA•CASCATA•NEBULIZZATO  
RAIN•WATERFALL•MIST SPRAY



SOFFITTO  
CEILING



CROMO  
CHROME

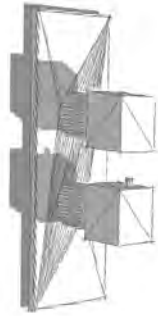
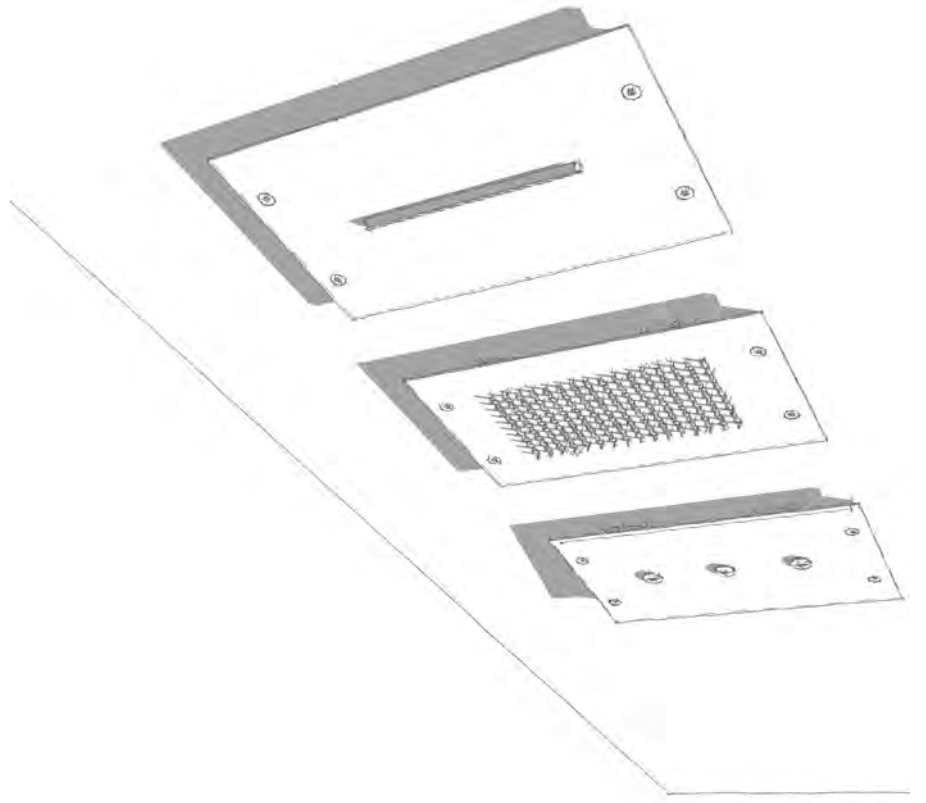

# COMPOSIZIONE 5

COMPOSITIONS

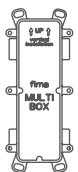

fimamultibox

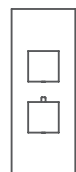
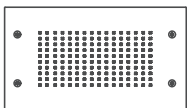

38°

THERMOSTATIC



#SHOWERHEAD

SHOWERH

#PASSION





LEAD





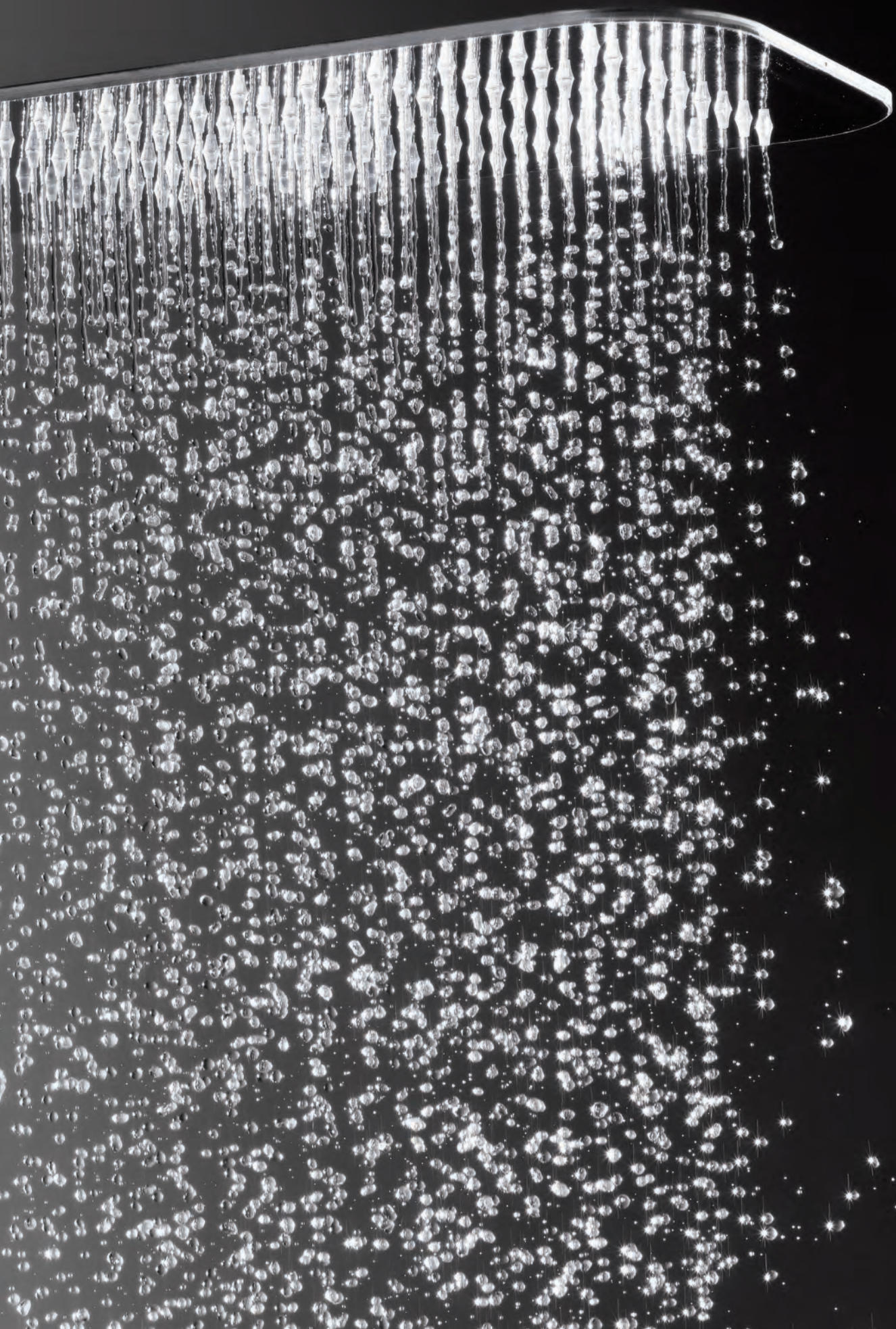

66



## SPECIFICHE TECNICHE • TECHNICAL SPECIFICATIONS



ACCIAIO INOX  
STAINLESS STEEL



15 L/MIN.



553x170 MM



PIOGGIA • CASCATA  
RAIN • WATERFALL



PARETE  
WALL



CROMO  
CHROME

# FUNZIONI DIFFERENTI NEL MINIMO SPESSORE

MULTIPLE FUNCTIONS IN A MINIMAL THICKNESS

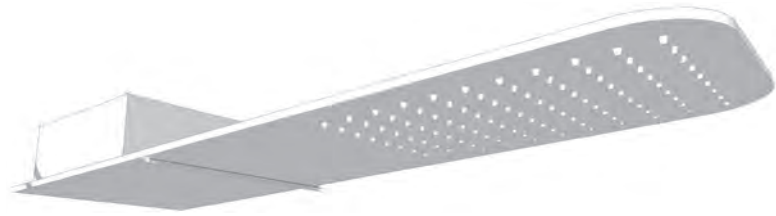
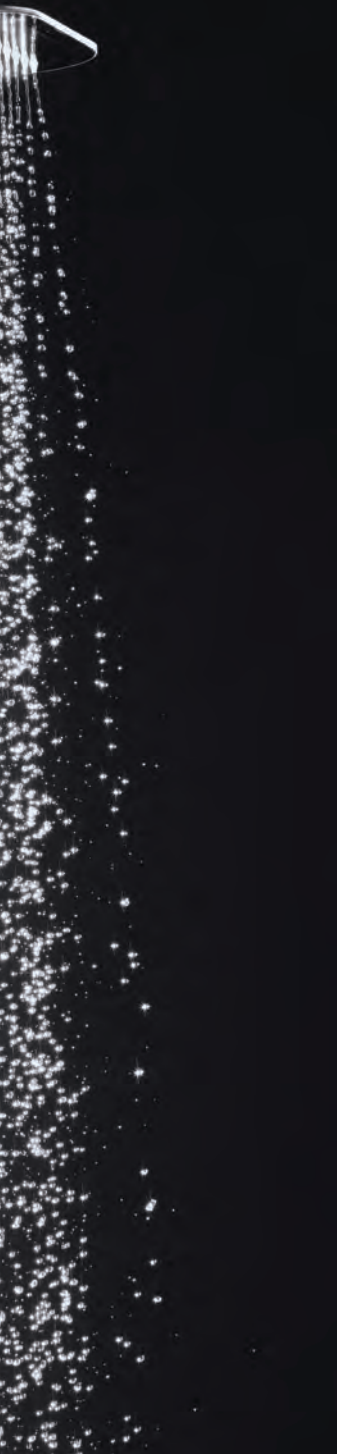

F2347



F2628



F2346

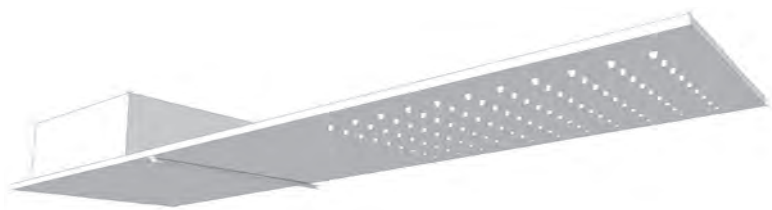

F2627



553 MM

170 MM



F2623



165 MM

250 MM

145 MM



300 MM



F2782



# COMPOSIZIONE 6

COMPOSITIONS

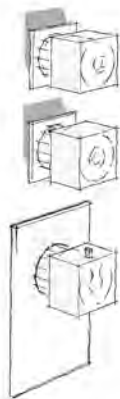
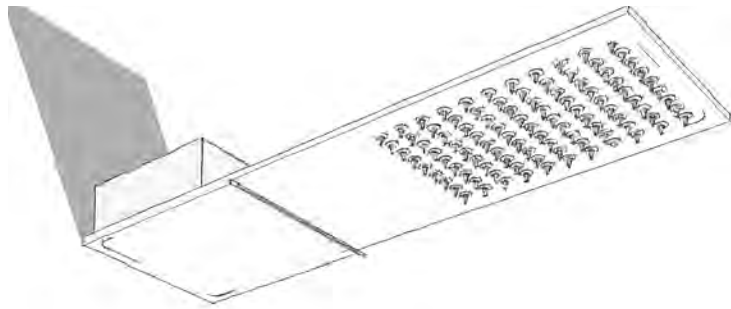

FIMATHERMBOX

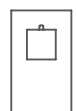
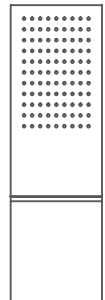

38

THERMOSTATIC





#SQUARE&ROUND

SQUARE  
ROUND

#COLORS





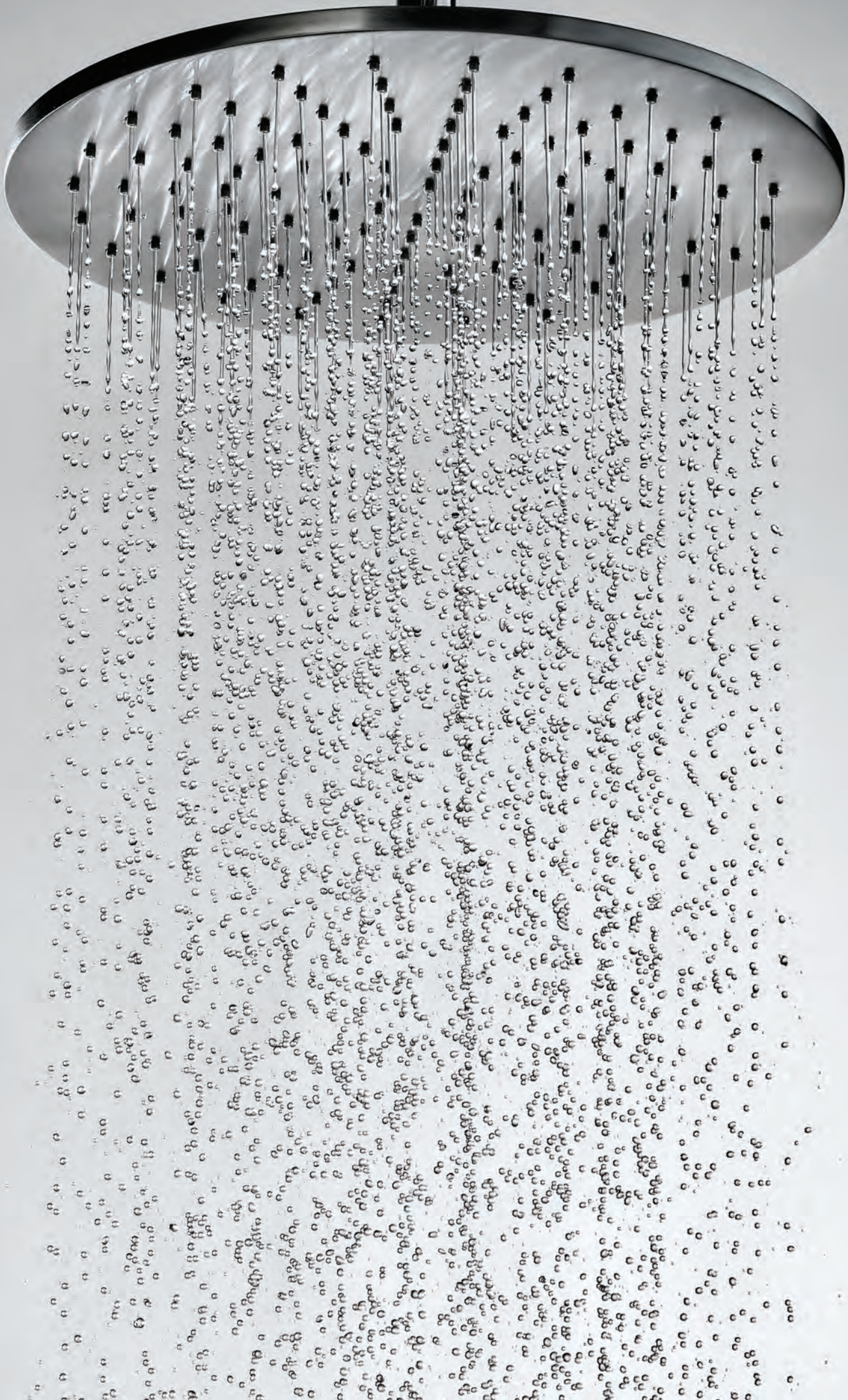

# FORME E DIMENSIONI DIFFERENTI PER LA MASSIMA PERSONALIZZAZIONE

DIFFERENT SHAPES AND DIMENSIONS FOR MAXIMUM CUSTOMIZATION

ROUND

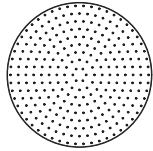

Ø 200

F2117/2  
OTTONE·BRASS

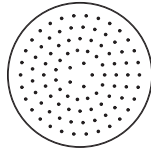

Ø 200

F2267/2  
ABS

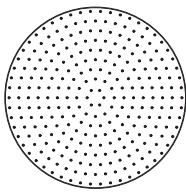

Ø 250

F2621/2  
OTTONE·BRASS

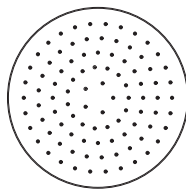

Ø 250

F2794/2  
ABS

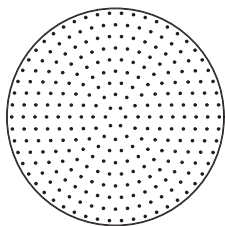

Ø 300

F2224/2  
OTTONE·BRASS

CLASSIC

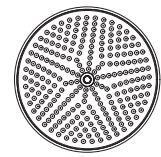

Ø 200

F2071/2  
OTTONE·BRASS

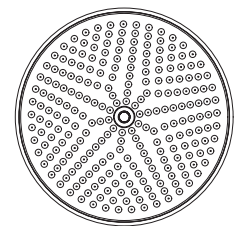

Ø 300

F2371/2  
OTTONE·BRASS

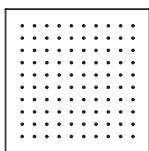

200x200

F2620/2  
OTTONE·BRASS

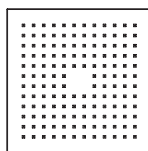

200x200

F2445/2  
ABS

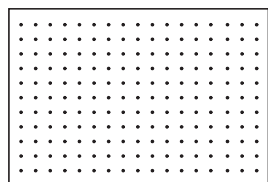

240x360

F2795/2  
ABS

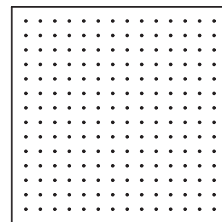

300x300

F2216/2  
OTTONE·BRASS

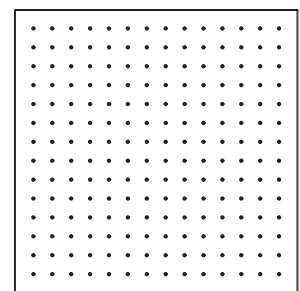

400x400

F2639/2  
OTTONE·BRASS

SQUARE



CROMO  
CHROME



NICKEL SPAZZOLATO  
BRUSHED NICKEL



BIANCO  
WHITE



NERO  
BLACK



BRONZO  
OLD BRONZE



ORO  
GOLD



RAME ANTICO  
OLD COPPER



RAME LUCIDO  
SHINY COPPER

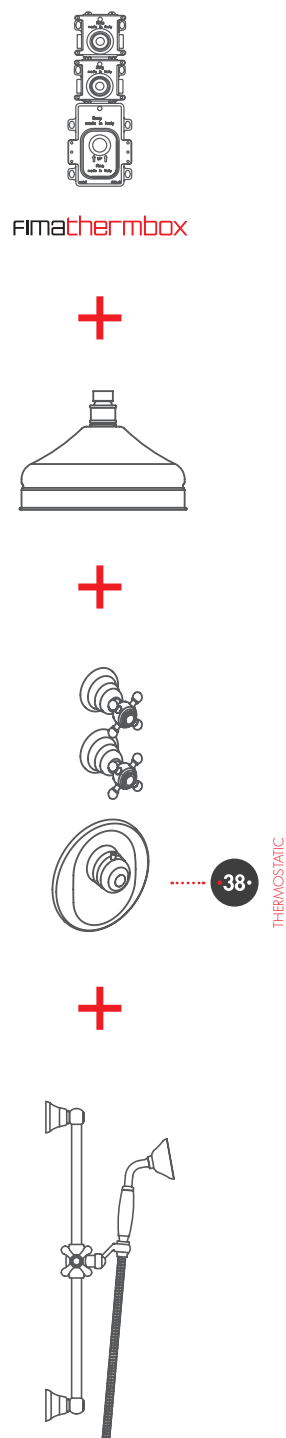
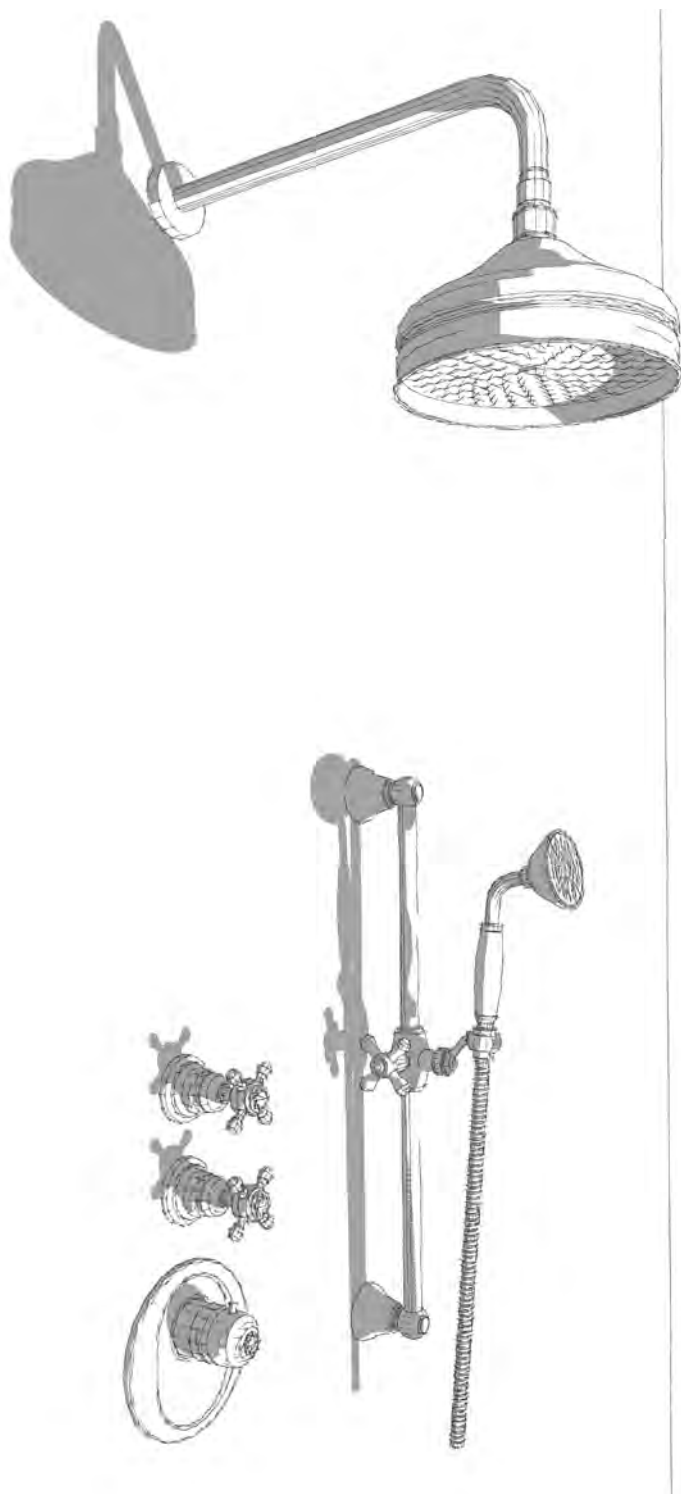

SPECIFICHE TECNICHE • TECHNICAL SPECIFICATIONS



OTTONE  
BRASS



15 L/MIN.



200 MM  
250MM  
300MM  
240x360MM



GETTO A PIOGGIA  
RAIN FLOW



PARETE•SOFFITTO  
WALL•CEILING



CROMO•CHROME  
BIANCO•WHITE  
NERO•BLACK  
NICKEL SPAZZOLATO•BRUSHED NICKEL  
BRONZO•BRONZE  
ORO•GOLD  
RAME ANTICO•OLD COPPER  
RAME LUCIDO•SHINY COPPER







#FIMABOXES

# IL CUORE DEL TUO AMBIENTE DOCCIA

THE HEARTH OF YOUR SHOWER SYSTEM



FIMATHERMBOX

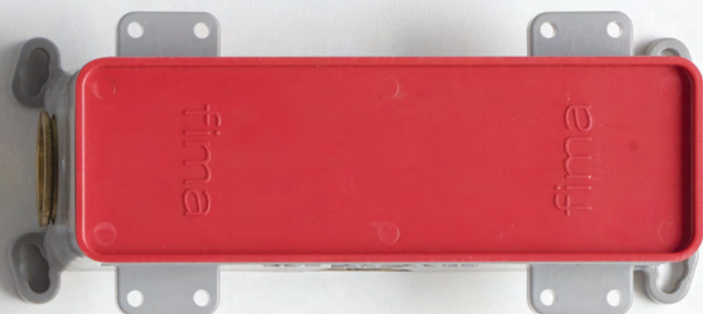

Fimatwin**box**



Fimamulti**box**



Fimab**box**

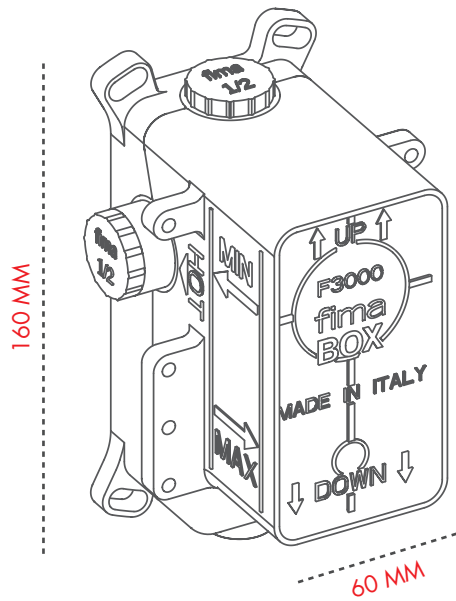

MECCANICO  
MECHANICAL



TERMOSTATICO  
THERMOSTATIC

COMPATIBILE CON PARTI ESTERNE SIA MECCANICHE CHE TERMOSTATICHE  
COMPATIBLE TO EITHER EXTERNAL MECHANICAL OR THERMOSTATIC SHOWER MIXERS



1.2 USCITE  
OUTLETS



UNIVERSALE PER TUTTE LE SERIE  
UNIVERSAL FOR ALL COLLECTIONS



FACILE DA INSTALLARE  
EASY INSTALLATION



CLASSE "A" PER RUMOROSITÀ  
CLASS "A" FOR NOISE  
UNI EN ISO 3822. < di 20dB max flow



NON TRASMETTE VIBRAZIONI  
DOES NOT TRANSMIT VIBRATIONS



IMPERMEABILE  
WATERPROOF



DEVIATORE PUSH & PULL  
PUSH & PULL DIVERTER



OTTONE DZR  
DZR BRASS

PROFONDITÀ INCASSO  
LESS PROTRUSIVE INSTALLATION

60MM

TOLLERANZA DI INSTALLAZIONE  
INSTALLATION DEPTH TOLERANCE

30MM

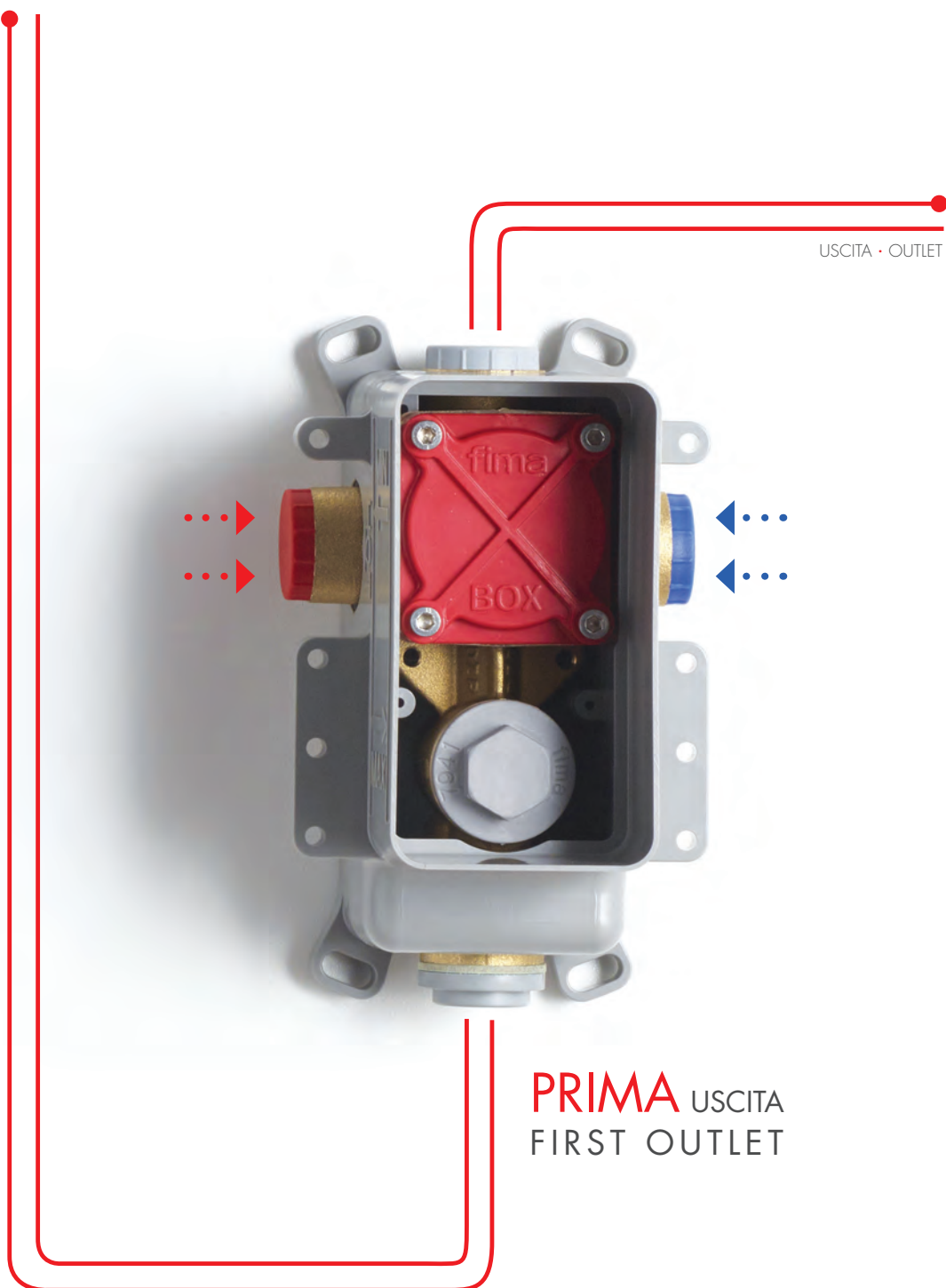

USCITA · OUTLET



**PRIMA** USCITA  
FIRST OUTLET

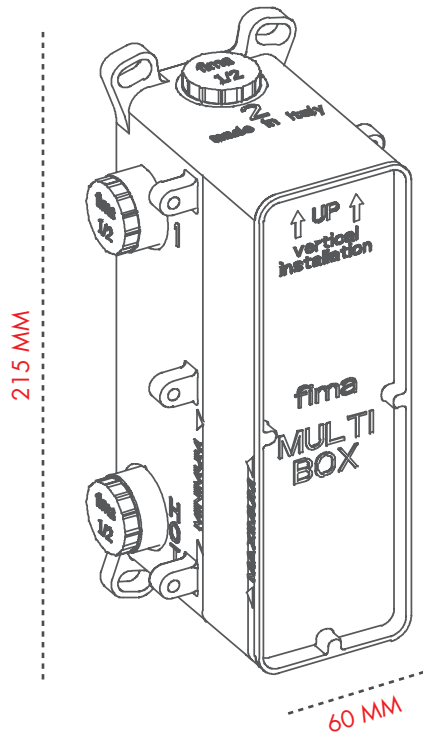

MECCANICO  
MECHANICAL



TERMOSTATICO  
THERMOSTATIC

COMPATIBILE CON PARTI ESTERNE SIA MECCANICHE CHE TERMOSTATICHE  
COMPATIBLE TO EITHER EXTERNAL MECHANICAL OR THERMOSTATIC SHOWER MIXERS



2·3 USCITE  
OUTLETS



UNIVERSALE PER TUTTE LE SERIE  
UNIVERSAL FOR ALL COLLECTIONS



FACILE DA INSTALLARE  
EASY INSTALLATION



NON TRASMETTE VIBRAZIONI  
DOES NOT TRANSMIT VIBRATIONS



IMPERMEABILE  
WATERPROOF



OTTONE DZR  
DZR BRASS

PROFONDITÀ INCASSO  
LESS PROTRUSIVE INSTALLATION

60MM

TOLLERANZA DI INSTALLAZIONE  
INSTALLATION DEPTH TOLERANCE

30MM

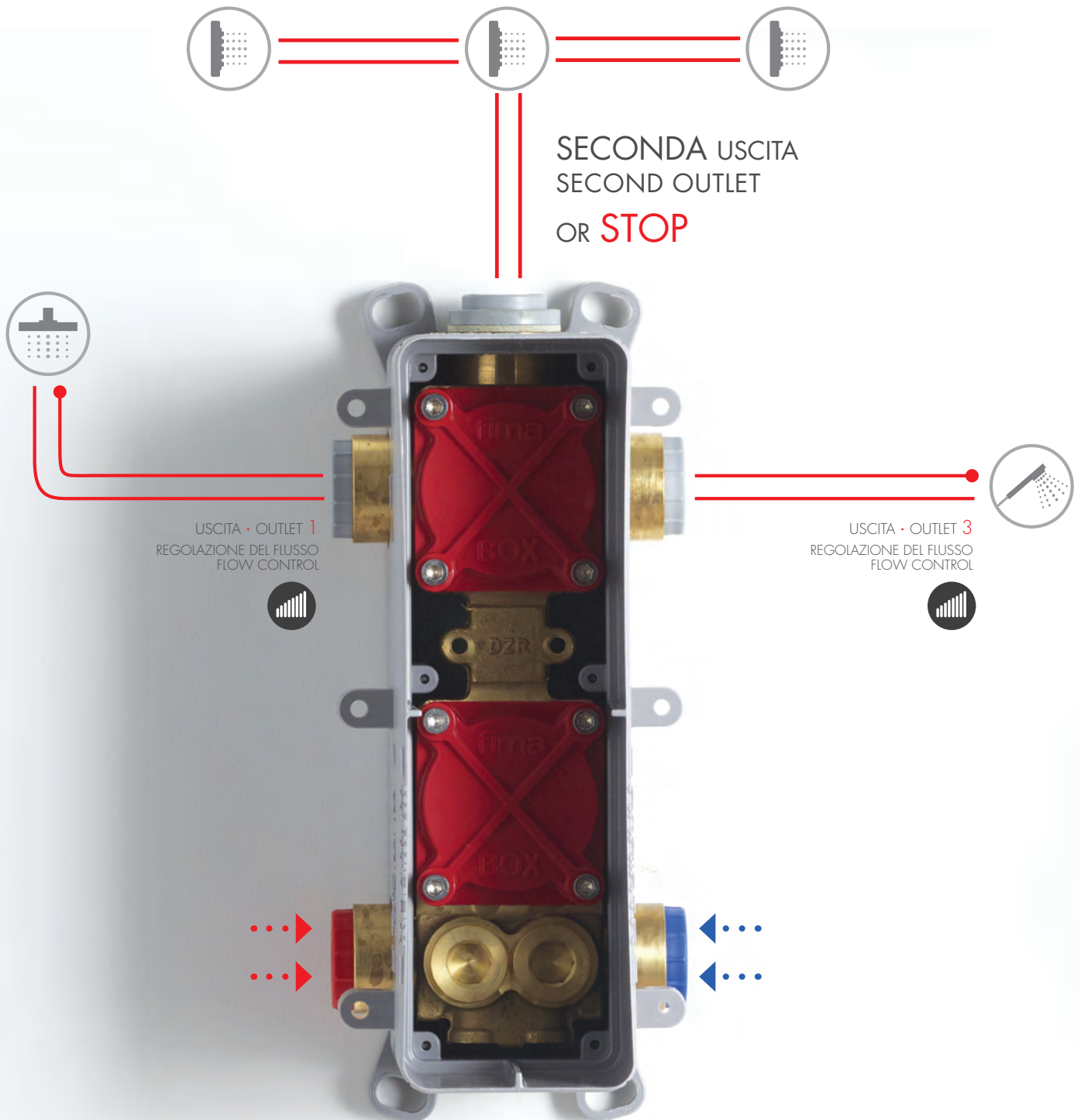

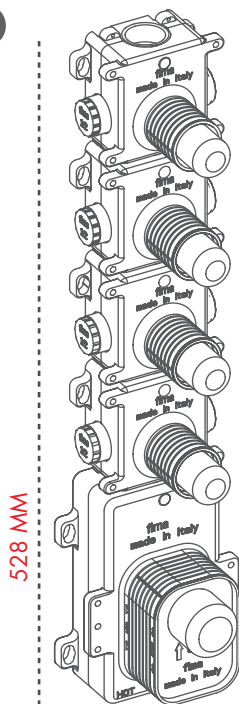

F2464

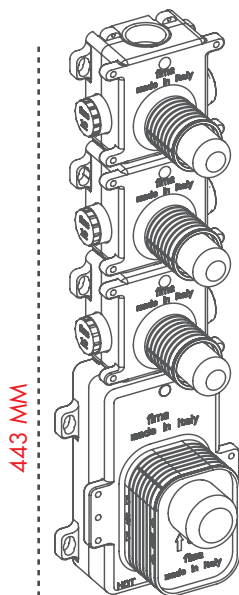

F2463

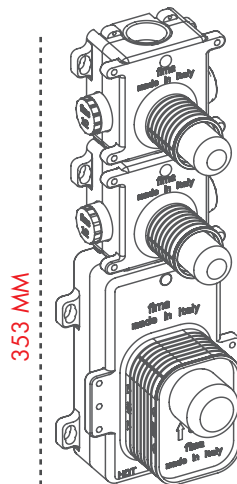

F2462

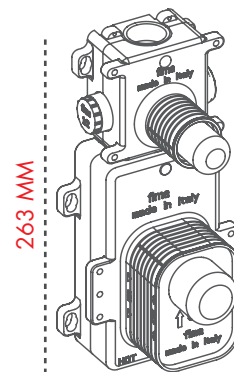

F2461



4 USCITE  
OUTLETS

3 USCITE  
OUTLETS

2 USCITE  
OUTLETS

1 USCITA  
OUTLET



UNIVERSALE PER TUTTE LE SERIE  
UNIVERSAL FOR ALL COLLECTIONS



FACILE DA INSTALLARE  
EASY INSTALLATION



NON TRASMETTE VIBRAZIONI  
DOES NOT TRANSMIT VIBRATIONS



IMPERMEABILE  
WATERPROOF



OTTONE DZR  
DZR BRASS



INSTALLAZIONE ORIZZONTALE O VERTICALE  
HORIZONTAL OR VERTICAL INSTALLATION



TUTTE LE USCITE CONTEMPORANEAMENTE  
ALL OUTLETS SIMULTANEOUSLY



TERMOSTATICO  
THERMOSTATIC



FINO A 50L.MIN.  
UP TO 50L.MIN.



PROFONDITÀ INCASSO  
LESS PROTRUSIVE INSTALLATION

60MM

TOLLERANZA DI INSTALLAZIONE  
INSTALLATION DEPTH TOLERANCE

30MM



USCITA · OUTLET

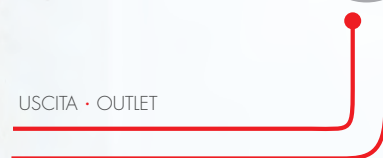

USCITA · OUTLET



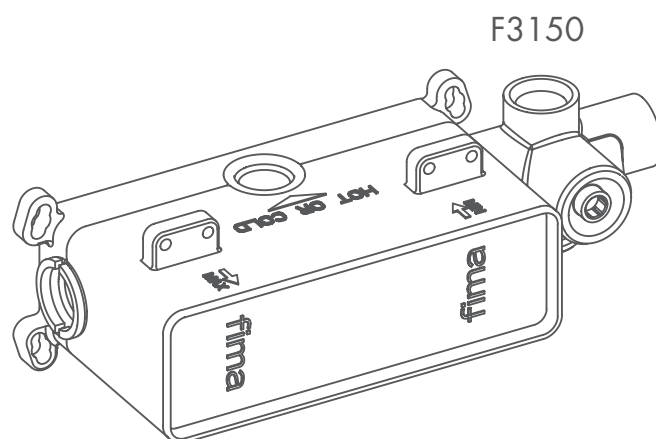
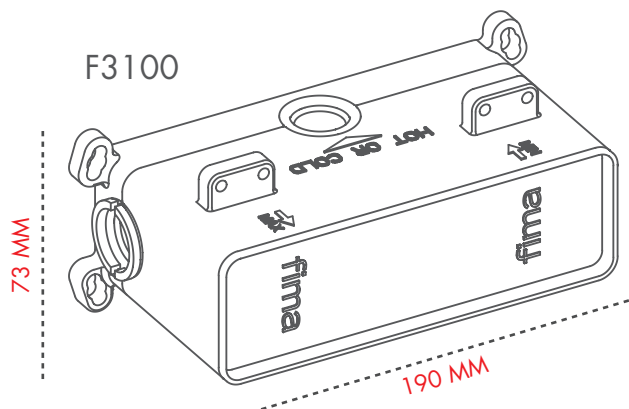

**2.3** USCITE  
OUTLETS



UNIVERSALE PER TUTTE LE SERIE  
UNIVERSAL FOR ALL COLLECTIONS



FACILE DA INSTALLARE  
EASY INSTALLATION



NON TRASMETTE VIBRAZIONI  
DOES NOT TRANSMIT VIBRATIONS



IMPERMEABILE  
WATERPROOF



OTTONE DZR  
DZR BRASS



GESTIONE INDIPENDENTE DELLA TEMPERATURA  
INDIPENDENT CONTROL OF TEMPERATURE



TUTTE LE USCITE CONTEMPORANEAMENTE  
ALL OUTLETS SIMULTANEOUSLY



MECCANICO  
MECHANICAL

PROFONDITÀ INCASSO  
LESS PROTRUSIVE INSTALLATION

72MM

TOLLERANZA DI INSTALLAZIONE  
INSTALLATION DEPTH TOLERANCE

30MM

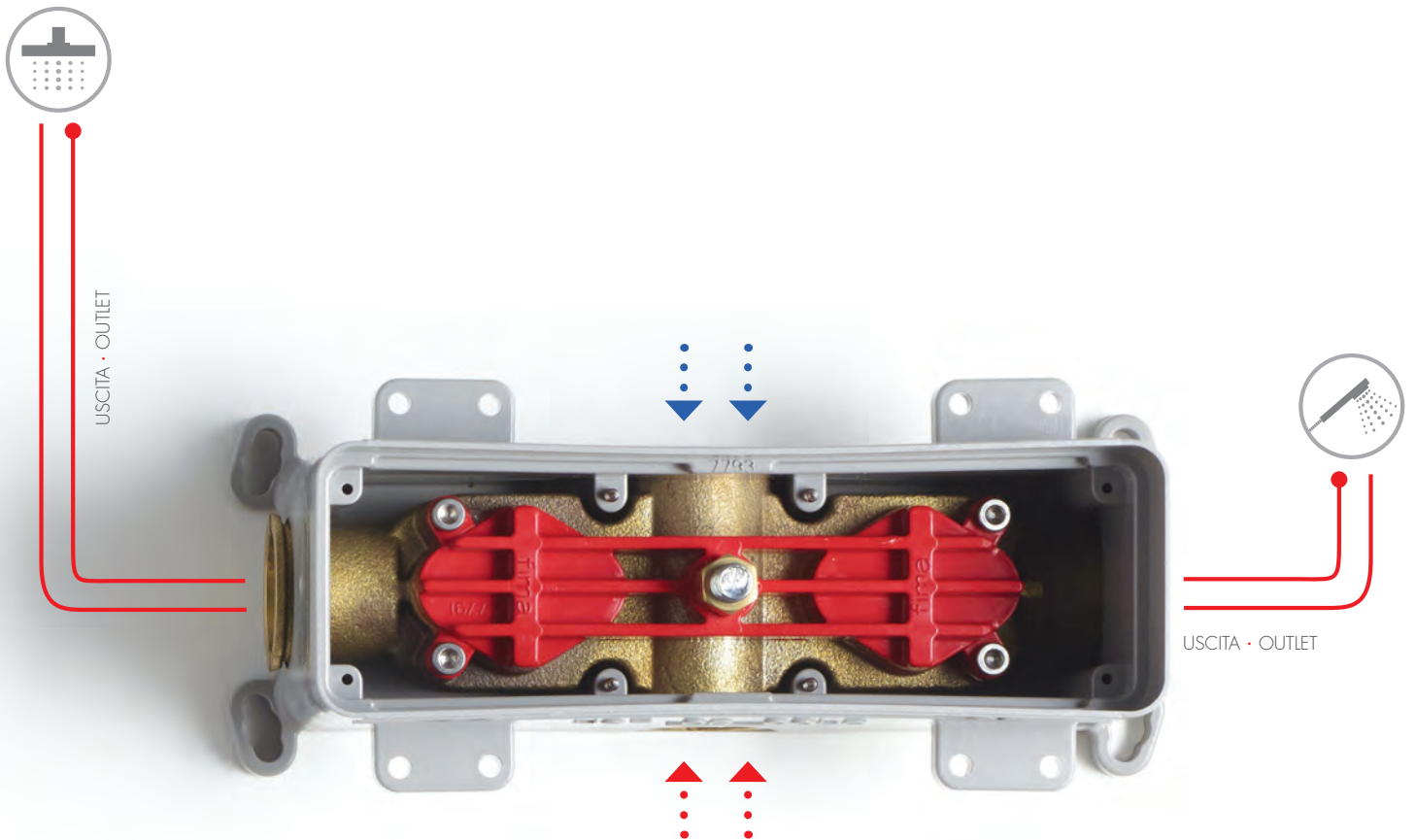

DOPPIO MISCELATORE CON GESTIONE  
INDIPENDENTE DI FLUSSO E PORTATA  
DOUBLE MIXER WITH INDEPENDENT CONTROL OF FLOW AND TEMPERATURE

## #NU

COMPOSIZIONE DOCCIA • SHOWER COMPOSITION PAG. 12 • 13

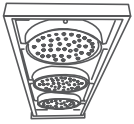

F2855CR

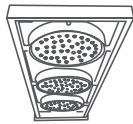

F2462



F3513X2CR

## #CLOUD

COMPOSIZIONE DOCCIA • SHOWER COMPOSITION PAG. 20 • 21

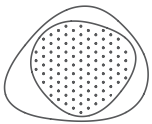

F2651BCR

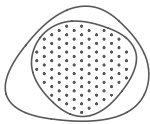

F2651NCR



F2461



F3253X1BS



F3253X1NS

## #SFERA

COMPOSIZIONE DOCCIA • SHOWER COMPOSITION PAG. 28 • 29



F2340CRB



F2220



F3243/1BS



# #HARMONIA

COMPOSIZIONE DOCCIA • SHOWER COMPOSITION PAG. 36 • 37

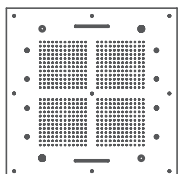

F2900CR



F2464



F5603X4HCR

# #MODULAR

COMPOSIZIONE DOCCIA • SHOWER COMPOSITION PAG. 44 • 45



F2805CR

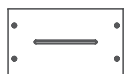

F2810CR



F2820CR



F2464



F5603X4VCR



F2287/4CR

# #SHOWERHEAD

COMPOSIZIONE DOCCIA • SHOWER COMPOSITION PAG. 52 • 53

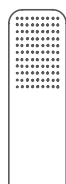

F2628CR

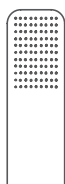

F3100



F3929X2CR

companies  
G-EXPERIENCE (DIEGO MARIA GUGLIERMETTO)

graphic project  
FIMA CARLO FRATTINI  
photo  
WALTER ZERLA





**Fima Carlo Frattini S.p.A.**  
28010 - Briga Novarese (NO)  
Via Borgomanero, 105  
tel. +39 0322 9549 (r.a.)  
fax. +39 0322 956149  
e-mail: [info@fimacl.com](mailto:info@fimacl.com)  
[www.fimacl.com](http://www.fimacl.com)

fima | CARLO FRATTINI®  
r a b i n e t t e r i e